



TYPES OF TOILET AND THEIR SUITABILITY

Introduction

Toilet types can be broadly split into two categories; on-site and off-site systems. Off-site systems are associated more with the developed world, cities and high density areas and often take on the form of sewerage systems which require a reliable water supply and the provision of wastewater treatment. Alternative on-site systems are isolated and provide some level of treatment or containment at the toilet location and avoid the need for further treatment. However, a number of on-site systems need regular emptying.

This technical brief outlines different types of toilets, whilst highlighting some advantages and disadvantages which will facilitate their planning and selection.

Off-site sanitation systems

Off-site systems are widely acknowledged as systems that are only suited to developed and affluent areas, whose water resources are plentiful and reliably delivered to household connections in enough quantities. In low income and less developed areas where water is often collected from a stand-post or well, dry (on-site) systems are the only possibilities. Despite this, there are alternatives to conventional sewerage that may sometimes be applicable.

One major consideration with sewerage systems is the required provision of wastewater treatment. This is a significant distinction from on-site systems which should treat waste in-situ or have no need to treat the waste as it is contained within the ground (although in some cases the faecal sludge within the latrine will be removed, after which it should be treated and disposed of safely).

Off-site sanitation systems generally involve the construction of long lengths of permanent infrastructure. Land ownership issues may result in investments of this level being unrealistic if government institutions do not back the development. The requirement to provide treatment means such involvement is likely to be necessary unless decentralised community operated facilities could realistically be established. In order to recover the costs of construction, operation and maintenance users of the system need to pay for a connection, this makes the likelihood of adopting such systems being restricted to densely populated urban areas where the number of connections per unit area is highest.

Conventional Sewerage

Conventional sewerage (employed widely in high income areas) is acknowledged to be based on criteria (such as minimum gradients and minimum cover levels) that must meet very conservative values (UNEP, 2002). This often results in deeper pipes which results in the necessity for pumping and thus increased operation costs.

In order to construct a sewerage network each property should have a toilet, the contents of which discharge to a household connection sewer, which will often include an inspection chamber to clear blockages. The waste will then discharge to a main sewer, on which manholes should be installed at set intervals. The size of the sewer pipes will get progressively larger until the waste is discharged to a treatment works; the sludge by-product from this will require further treatment.

Simplified Sewerage

In response to the conventional conservative design criteria and in an attempt to reduce cost, simplified sewerage has been developed. This results in less excavation due to pipes being buried shallower and downstream pipes being shallower (as a result of reduced gradients) thus reducing pumping costs. In addition material costs are reduced through smaller pipe diameters and inspection chambers replacing manholes in some instances. The consequence of all these improvements is to reduce the cost passed on to the final user (although comparatively this could still remain high).

In some cases high population density, narrow streets, high groundwater and rocky ground can make on-site sanitation problematic, in these cases simplified sewerage may be worth investigating further.

Condominial Sewerage

The condominial approach to sanitation services (which can also be applied to water services) was first developed in Brazil during the 1980s (Melo, 2005). In this system a service provider will provide a sewerage connection point at the edge of a group of houses. The members of this community are then expected to work together (possibly through CBO structures) to create condominial sewerage that connects to this main sewer. The condominial sewerage generally utilises simplified sewerage design criteria. A number of very successful programmes, such as the Orangi Pilot Project in Pakistan, have used a similar technology.

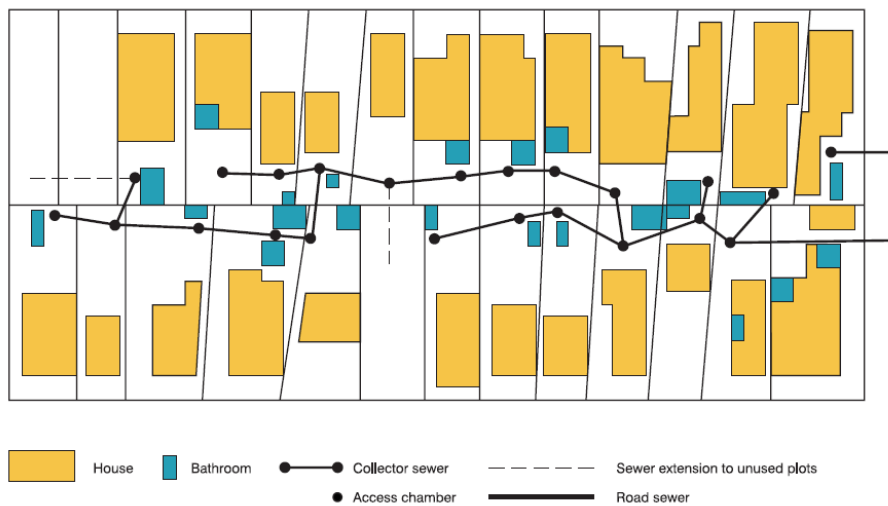

Figure 1: Condominial Sewer Layout in Petrolina, Brazil
(Source: WELL, 1998)

Settled Sewerage Systems

These systems contain an intermediary tank on the house connection sewer. This system allows the solids to settle out from the sewage and make the further transportation simpler. This lack of solids means the sewer does not have to be laid on a constant gradient and can travel up and down reducing the necessity for pumping and keeping sewer depths at a reasonable depth. The systems were first developed in Australia as a means of conveying overflow from failing septic tanks – a function that can be served in developing cities where septic tank effluent is not safely absorbed into the ground.

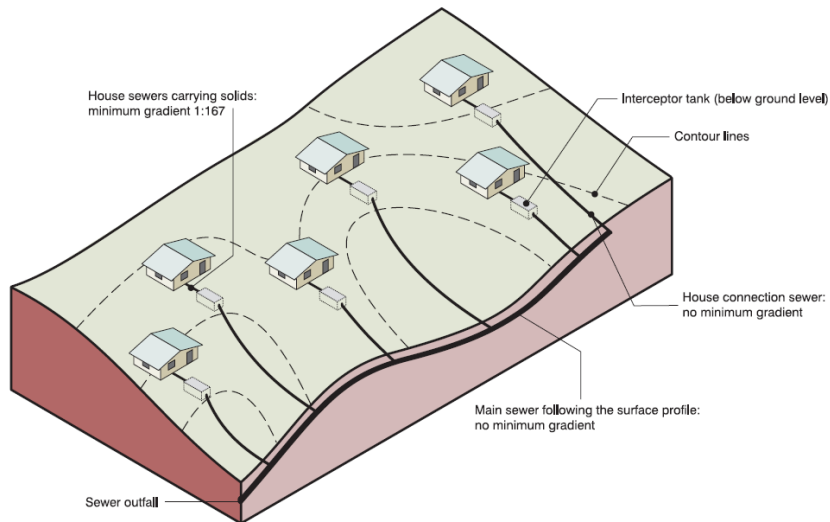

Figure 2: A schematic cut-away view of a sewerage interceptor system (Source WELL, 1998)

One major drawback of the settled sewerage approach is the necessity to empty the interceptor tank. In many urban areas sewerage is required to replace failing septic (or other on-site sanitation systems) which require emptying but are hindered by poor access or poor service provision. □

On-site Sanitation Systems

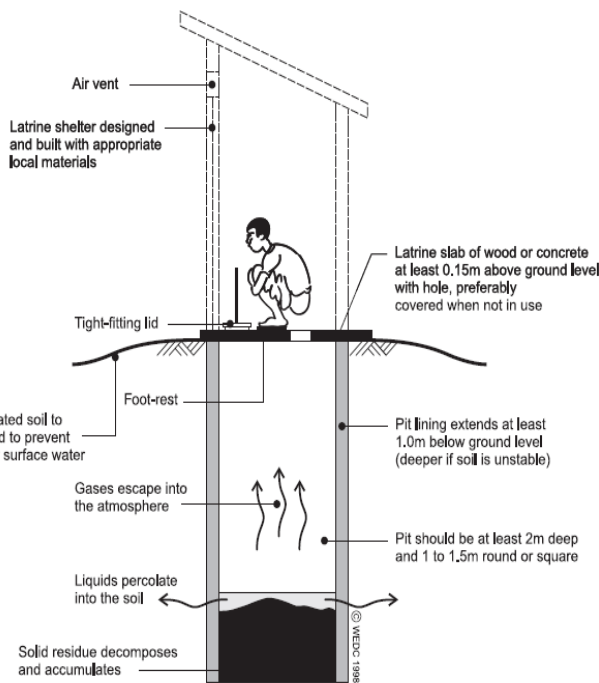

Figure 3: A simple pit latrine (Source: Harvey et al, 2002)

Simple Pit Latrine

On-site sanitation systems are more widely employed in low income and rural areas of the world. Numerous forms have been developed ranging in both price and complexity. A number of publications exist that outline the features of different types and the consequences of employing them. This brief simply outlines the range of technologies in common use and the main advantages and disadvantages.

Depending on the types of latrine adopted the cost to the householder may be (relatively) much less than with off-site systems and would generally be covered in one lump sum for the construction of the facility (although the cost of

emptying can be large in some cases). Each latrine type will provide both advantages and disadvantages, and are generally more appropriate for rural areas. Odour, flies and the need for emptying are the most important considerations associated with on-site systems.

A simple pit latrine (figure 3) is perhaps the simplest and the first step among sanitation solution identified by the UN to meet the criteria of the Millennium Development Goals (JMP, 2004). In reality the variance in the standard of these facilities can be great. The JMP distinction is that the latrine should have a superstructure to be acceptable to users.

The simplest form of pit latrine is a hand dug pit that is unlined and covered with a series of wooden logs strapped together allowing the user to defecate into the pit. This system can gradually be improved as illustrated in figure 7.

Advantages	Disadvantages
Construction costs are low (householders can perform a large part of the work themselves) Technology is simple and understandable	Possible groundwater contamination if the pit is not completely lined Not easy to construct in rocky or unstable ground
Allow range of anal cleansing materials Do not require water to operate	Fly and smell nuisance

Raised Latrines: When the groundwater is high or the ground is too rocky to excavate by hand there is a case for using a raised pit latrine (other latrine types can also be raised although it is more common for simple pit latrines to be raised). One major disadvantage is the lack of privacy afforded to the users of the latrines. More information is provided by Scott (2005).

Slab type: There are numerous types of slabs that can be used for a latrine, each with different benefits. The purpose of the slab is to hold the weight of the user over the pit, provide a clean surface for the users feet and drain liquids into the squat hole. A variety of materials can be used such as timber, reinforced concrete and un-reinforced concrete slabs in a dome shape to avoid tensile forces. San-plats are often added onto traditional latrine slabs to provide a clean surface, foot plates and a suitably shaped squat hole.

Stoppers : Flies and smells can be the biggest problems associated with simple pits which can be controlled to some extent with a drop-hole cover or stopper.

Ventilated Improved Pit (VIP) Latrine

During the 1980s the VIP latrine was developed in Zimbabwe. The main drivers for design were to eliminate two unpleasant aspects of using on-site sanitation systems, flies and smell. Furthermore, the reduction of flies can also reduce the transmission of disease.

Put simply, the technology facilitates the flow of air through the system. One important aspect is that the inside of the toilet should remain dark as means of attracting flies up a vent pipe where they will eventually die and fall back into the latrine. Further information and details on construction can be found in the Practical Action technical brief 'Ventilated Improved Pit Latrine'.

Advantages	Disadvantages
Construction costs are low (householders can perform a large part of the work themselves) Technology is simple and understandable	Possible groundwater contamination if the pit is not completely lined Not easy to construct in rocky or unstable ground
Allow the use of a range of anal cleansing materials Do not require water to operate	Does not control mosquitoes
Controls smells and flies	Vent pipe increases costs and can make construction more complicated Need to keep inside of latrine dark Increased odour outside

Pour-Flush Latrine

Where water is more widely available, or traditionally used for anal cleansing, a pour flush latrine may be appropriate and can bring a number of further benefits on top of simple or VIP latrines. A water-seal is created by a plastic u-bend which prevents bad odour and flies affecting the user (this system is less susceptible to building errors than the VIP system). The system only requires a few litres of water and so should not put a strain on resources and could be provided by greywater from the kitchen.

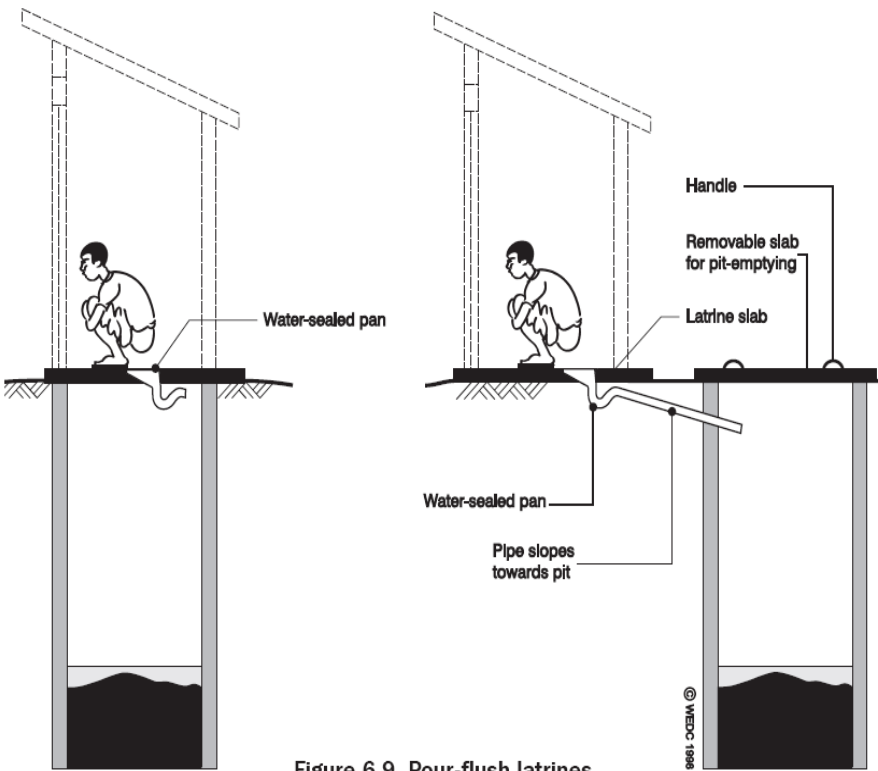

Figure 6.9. Pour-flush latrines

Figure 4: A pour-flush latrine set over a pit latrine (left) and discharging to an offset pit (right) (Source: Harvey et al, 2002)

Advantages	Disadvantages
The system effectively reduces levels of flies, mosquitoes and odour	Requires a supply of water to operate the system
The system can incorporate an offset pit (see below) and so can be installed inside a household	The water seal prevents the use of solid anal cleansing materials
The installations are easy to keep clean	The plastic pan requires increased skill to produce
They work easily i.e. the construction is not as complicated as a VIP latrine	More expensive than simpler types

Offset pits : These are a means of improving the operational nature of a latrine, but may increase the cost of construction and increase the complexity of the system. Two main advantages of employing an offset pit are to make emptying easier without having to disturb the superstructure and they can also enable the toilet to be constructed inside the house.

Single or Double Pit : It is also possible to include a double pit, this involves the need to change the direction of flow between pits. The advantage of a double pit is that the contents of one pit gradually decompose over time whilst the other pit used and become safer to remove. The sanitation facility also becomes a more permanent piece of infrastructure as the superstructure never has to be removed. One area for caution is to ensure that the double pits are operated correctly, in some cases it has been observed that incorrect use means the contents of one pit are not safe to remove (Pickford, 1995).

technical brief

Ecological Sanitation Latrines

Ecological sanitation (ecosan) latrines have been developed employing the concept that human waste contains nutrients that should be returned to the soil and used to grow more food. There are different types of toilet, which treat the waste to some extent prior to using the by-product to increase fertility of land. The types of toilet can be split into dehydrating and composting types with urine diversion often being employed to make the most of the nutrients available.

More information can be found in the Practical Action technical notes 'Ecological Sanitation: A Concept' and 'Re-use of Faeces and Urine from Ecological Sanitation'.

Advantages	Disadvantages
Recognises urine and faeces as useful by-products which can provide users with a cheap fertiliser and soil conditioner Reduces pollution problems associated with some forms of wastewater disposal	Require appropriate training of users to ensure the systems are operated correctly and people not put at risk Typically systems do not accept a wide variety of anal cleansing materials More expensive than simpler types of latrine

Aqua-Privy

An aqua-privy functions in a similar manner to a septic tank whilst avoiding the need for a consistent water supply to operate a flush toilet. The water will drain off the top and the sludge needs to be emptied on a regular basis. An advantage of the aqua privy is that it reduces odours. However, regular emptying could become an onerous requirement.

Figure 5: An aqua privy
(Source: Harvey et al, 2002)

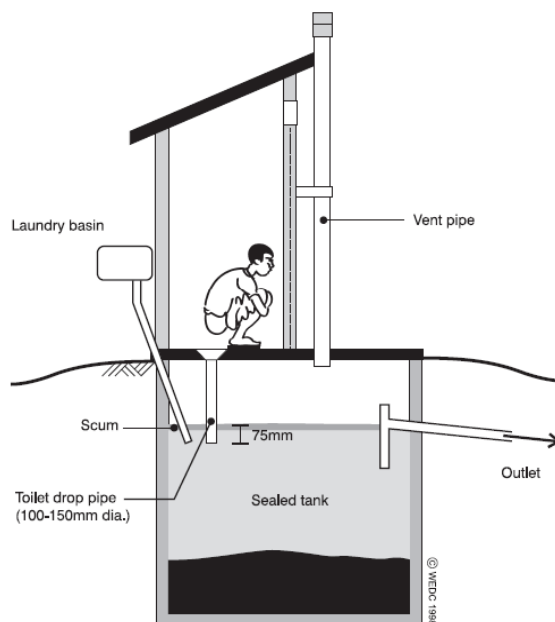

Advantages	Disadvantages
Does not require a piped water supply as a user can defecate directly into the tank It is a cheaper form of a septic tank	The system can fail to reduce smells if the water seal is not maintained Water must be available and plentiful Requires emptying Permeable land is needed to drain effluent

Septic Tanks

A septic tank is a water tight tank that typically receives waste from a flush toilet. They are useful in areas with a high water table (due to the sealed nature contamination of the water table is less likely) and when a reliable water supply is present. The system provides some level of treatment to the waste through the separation of solids.

The tank should be emptied routinely to ensure effluent does not contain unsafe levels of pathogens and that the sludge does not occupy too high a proportion of the tank. Ideally the effluent from the septic tank should be attached to a sewerage system, however in many cases the outlet is connected to a drainage field (if this is the case the ground should be permeable enough to prevent ponding). This liquid effluent will not be completely clear of contaminants hence the requirement to avoid ponding.

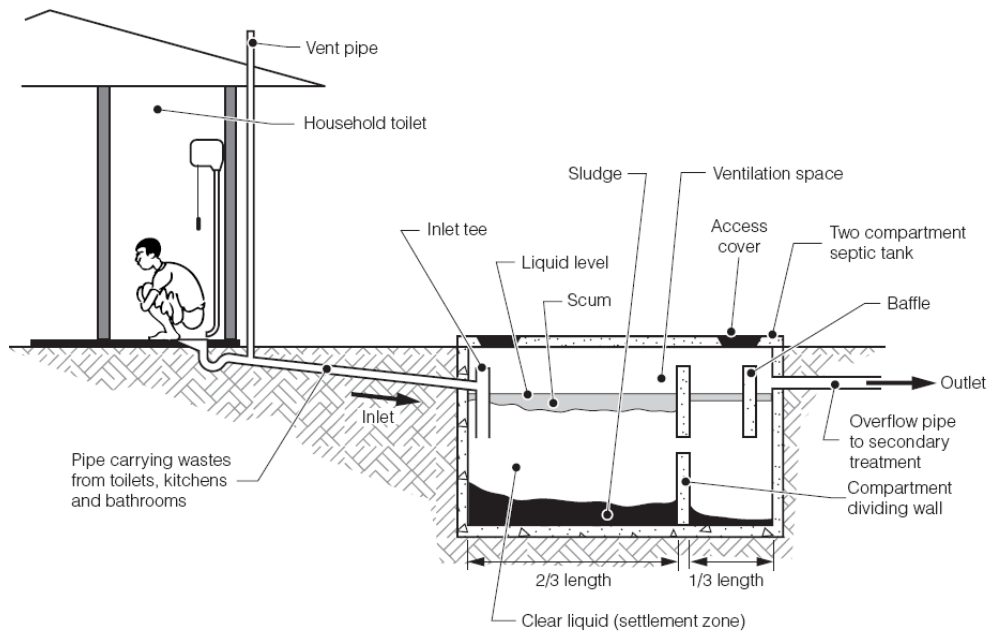

Figure 6: Septic tank layout (Source: Harvey et al, 2002)

Advantages	Disadvantages
The system reduces the level of odour and flies The user has the convenience of a WC which can be located indoors	The system comes at a high cost – including the cost of land Water is required (both in quantity and reliability) Permeable soil is required for drainage Requires regular emptying

Other Forms of On-Site Sanitation

There are other forms of sanitation which are less used or unsanitary. Borehole latrines are often used in emergency situations but adopted less elsewhere. Unsanitary forms would include overhung latrines which will dispose directly into a watercourse, or bucket latrines where users defecate into a bucket which is routinely emptied.

Groundwater Pollution

An important consideration when employing on-plot sanitation systems is that of groundwater pollution. Due to the nature of on-site systems shallow groundwater can be exposed to the pathogens within faeces and become contaminated. In urban areas this can be particularly problematic especially if shallow groundwater is used for drinking. In general it is possible to reduce this risk by locating a latrine at least 10m horizontally from a groundwater source. There is often debate as to the costs associated with alternative sanitation systems as oppose to alternative water sources. An alternative means to reduce the risk of contamination to groundwater is to employ a raised pit latrine.

Emptying Latrines

Decomposition of waste takes place to some extent but eventually the superstructure will have to be located and a new pit excavated, or the pit will need to be emptied. The biggest problems become apparent in urban locations where there is little space to relocate or access a latrine and where increased population density increases loading on latrines and thus increases filling rates. The waste must also be safely disposed of, or else the very pollution sanitation was designed to avoid will still take place.

technical brief

The options available for emptying and notes about filling rates and other important considerations can be found in the Practical Action technical brief 'Pit-Emptying Systems'.

Upgrading sanitation type

One useful consideration to note is that on-site sanitation systems are not necessarily confined to one type. If designed with forethought then a toilet can be upgraded gradually as a means to progressively improve the service or adapt it to changing conditions.

Communal Latrines

Each of the above types of system can be scaled up and incorporated into communal blocks to provide sanitation facilities in public blocks such as bus stations and markets or institutions such as schools. If water seals are not used it is advisable to provide each cubicle with a separate pit and vent pipe to prevent odour problems.

Responsibilities for communal facilities must be carefully assigned so that the facilities do not fall into disrepair.

Conclusion

There are many types of toilet that can be adopted to increase sanitation coverage. This technical brief has outlined some of the main options available and the advantages and disadvantages associated with each. In general off-site systems are used for urban areas, whereas on-site systems are used in both rural and urban areas.

Each system provides various advantages and disadvantages. It is of primary importance to consult the end users of these systems to ensure they get a system that is appropriate to their needs.

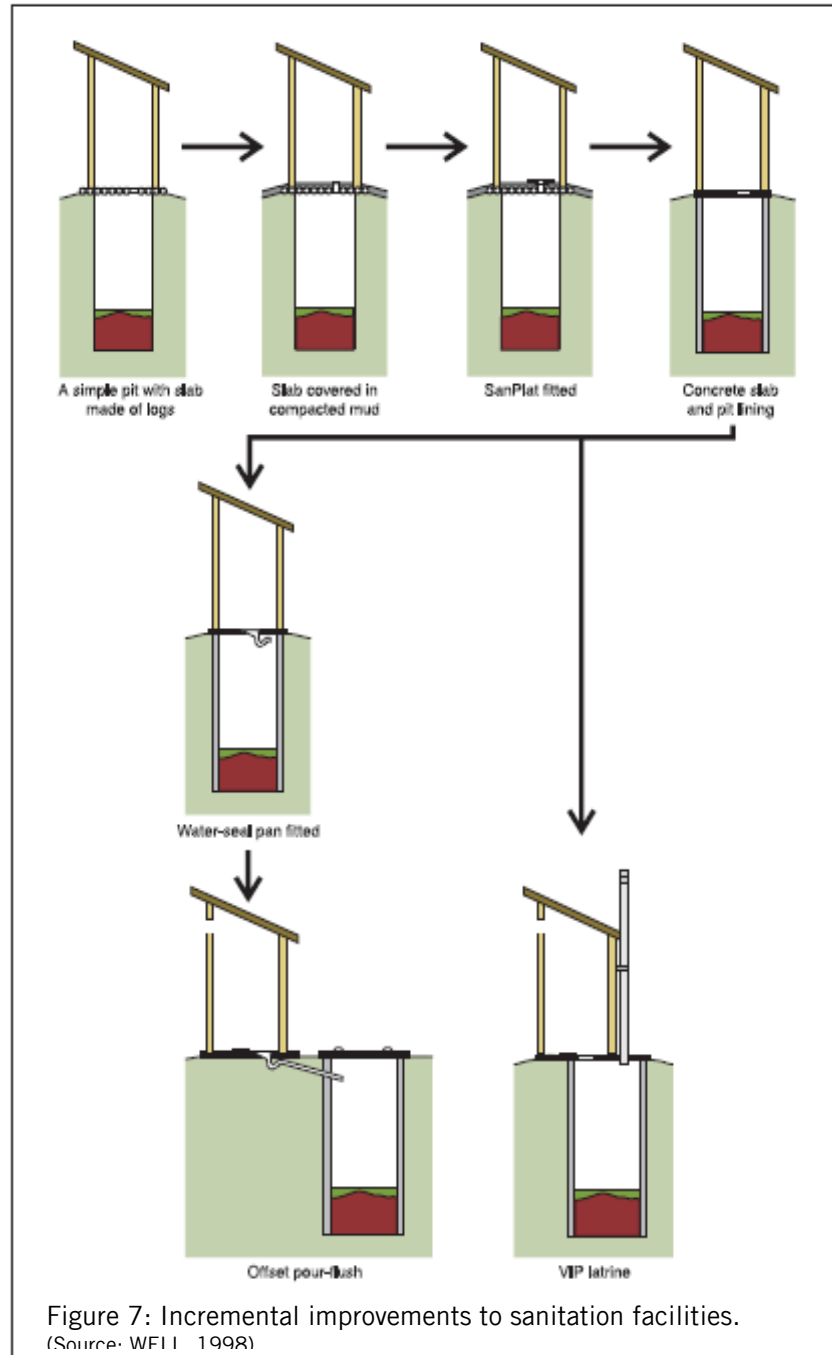

References and Further Reading

- [*Low-cost Sanitation; A survey of practical experience*](#), J. Pickford, 1995, Practical Action Publishing, ISBN 9781853392337
- [*Environmental Sanitation*](#), S.A. Esrey, U. Winblad et. al. 1999 SIDA. Sweden.
- [Composting Toilets](#) website
- [*Ecological Sanitation in India and Sri Lanka*](#), Paul Calvert
- [*Ecological Sanitation a Success in Sri Lanka*](#) Paul Calvert, Ajith Seneviratne, D.G.J. Premakumara and Udani A. Mendis Waterlines Vol.21 No 1 July 2002
- [*Toilets that Make Compost*](#) P Morgan Practical Action Publishing 2008
- [*Shit Matters*](#), Mehta and Movik Practical Action Publishing 2010
- Practical Action Technical Briefs [Waste Management Sanitation Technologies](#)
- Practical Action Publishing titles on [Sanitation](#)
- *Environmental Health Engineering in the Tropics: An Introductory Text* Second Edition. Cairncross S, Feachem R (1993) Wiley, UK
- [*A guide to the development of on-site sanitation*](#). Franceys, R., Pickford, J. and Reed, R. (1992) World Health Organisation (WHO), Geneva.
- [*Emergency Sanitation: Assessment and programme design*](#). Harvey, Peter, Baghri, Sohrab and Reed, Bob (2002) Water, Engineering and Development Centre (WEDC), Loughborough University, UK.
- [*Meeting the MDG Water and Sanitation Targets*](#). JMP (2004) Joint Monitoring Program (JMP) conducted by WHO and UNICEF.
- *The Experience Of Condominial Water And Sewerage Systems In Brazil*. Melo, Jose Carlos (2005) Water and Sanitation Program (WSP).
- [*On-Site Sanitation in Areas with a High Groundwater Table*](#). Scott, Rebecca (2005) WELL Factsheet. WELL, Loughborough University, UK.
- [*Health Impacts of Improved Household Sanitation*](#). Scott, Beth (2006) WELL Factsheet, WELL, Loughborough University, UK.
- UNEP (2002) [*International Source Book On Environmentally Sound Technologies for Wastewater and Stormwater Management*](#). United Nations Environment Program (UNEP) website.
- WELL (1998) [*DFID Guidance manual on water supply and sanitation programmes*](#). British Department for International Development (DFID), produced by WELL, Loughborough University, UK.

This Technical Brief was produced by Niall Boot for Practical Action, August 2008.

Practical Action
 The Schumacher Centre
 Bourton-on-Dunsmore
 Rugby, Warwickshire, CV23 9QZ
 United Kingdom
 Tel: +44 (0)1926 634400
 Fax: +44 (0)1926 634401
 E-mail: inforsew@practicalaction.org.uk
 Website: <http://practicalaction.org/practicalanswers/>

Practical Action is a development charity with a difference. We know the simplest ideas can have the most profound, life-changing effect on poor people across the world. For over 40 years, we have been working closely with some of the world's poorest people - using simple technology to fight poverty and transform their lives for the better. We currently work in 15 countries in Africa, South Asia and Latin America.

technical brief